

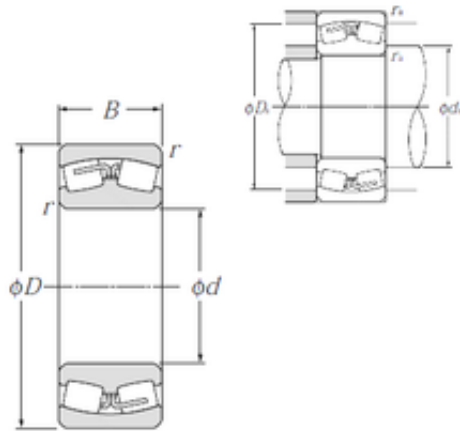

BEARING PRECISION AXLE CORP.

23180B NTN Spherical Roller Bearings



Bearing No. 23180B

Size	400x650x200 mm
Bore Diameter	400 mm
Outer Diameter	650 mm
Width	200 mm
d	400 mm
D	650 mm
B	200 mm
C	200 mm
r min.	6 mm
da min.	428 mm
Da max.	622 mm
ra max.	5 mm
Weight	264 Kg
Basic dynamic load rating (C)	4 200 kN
Basic static load rating (C0)	8 050 kN
(Grease) Lubrication Speed	430 r/min
(Oil) Lubrication Speed	560 r/min
Calculation factor (e)	0,31
Calculation factor (Y0)	2,16
Calculation factor (Y1)	2,21

23180B Bearing 2D drawings and 3D CAD models