

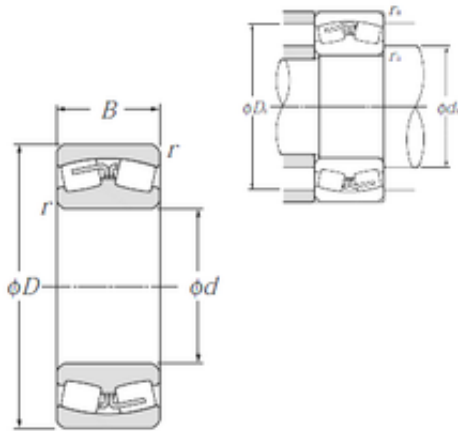

BEARING PRECISION AXLE CORP.

24080B NTN Spherical Roller Bearings



Bearing No. 24080B

Size	400x600x200 mm
Bore Diameter	400 mm
Outer Diameter	600 mm
Width	200 mm
d	400 mm
D	600 mm
B	200 mm
C	200 mm
r min.	5 mm
da min.	422 mm
Da max.	578 mm
ra max.	4 mm
Weight	202 Kg
Basic dynamic load rating (C)	3 850 kN
Basic static load rating (C0)	8 400 kN
(Grease) Lubrication Speed	460 r/min
(Oil) Lubrication Speed	600 r/min
Calculation factor (e)	0,32
Calculation factor (Y0)	2,04
Calculation factor (Y1)	2,09

24080B Bearing 2D drawings and 3D CAD models